

# Square S chain

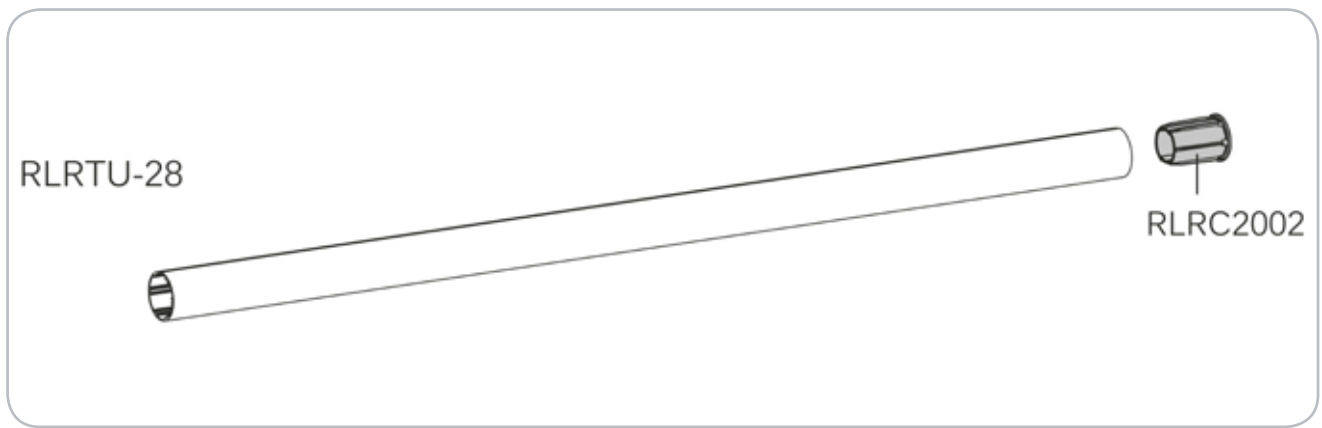

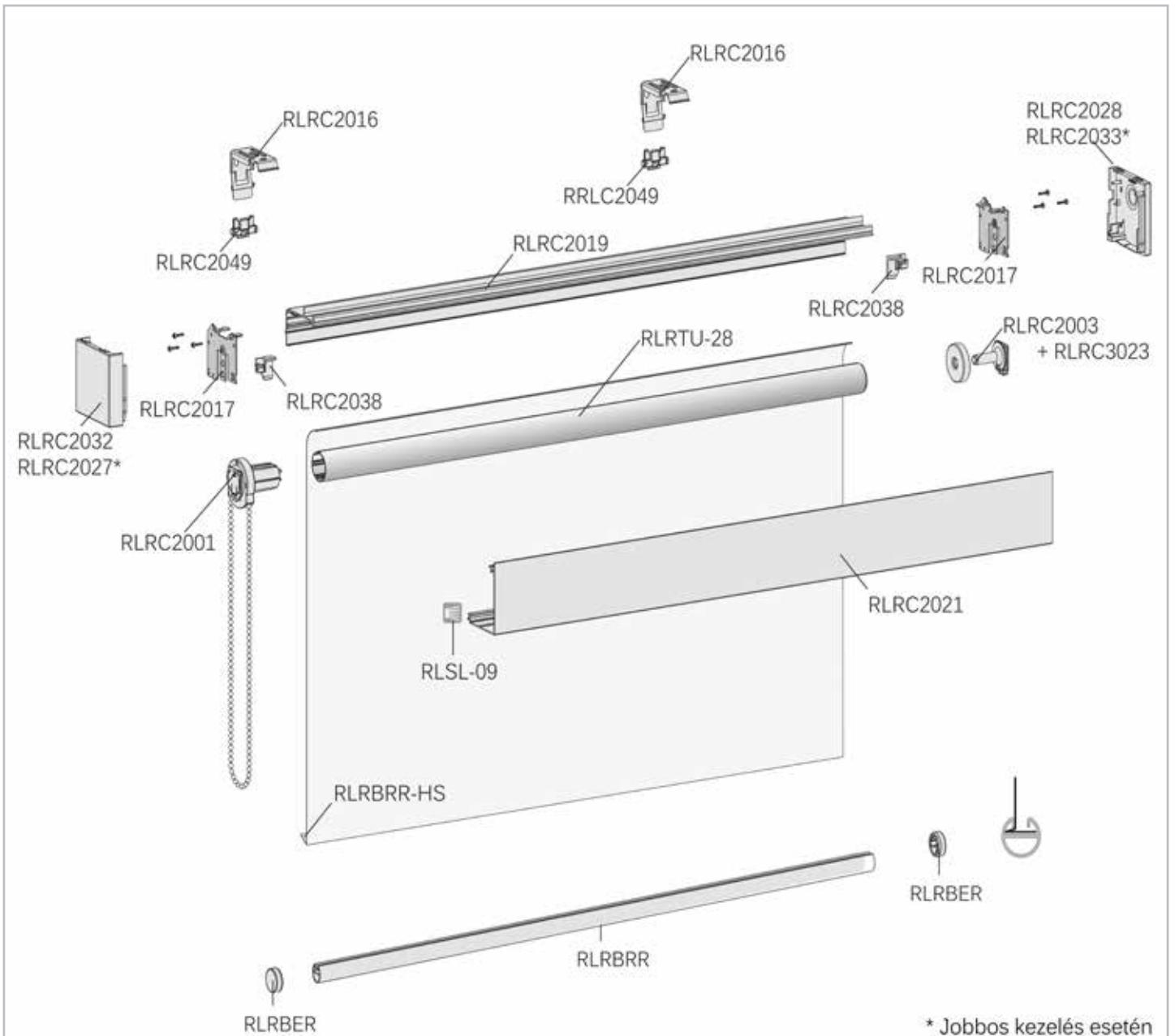





# SQUARE S CHAIN

	CIKKSZÁM / INDEX	MEGNEVEZÉS	ARTICLE	KISZERELÉS	MOQ
	RLRTU-28	alumínium csőszelvény Ø 28 mm	roller blind tube, aluminium, 28 mm, 580 cm	1 szál - 5,8 m	1 profile - 5,8 m
	RLRTU-38	alumínium csőszelvény Ø 38 mm, 580 cm	roller blind tube, aluminium, 38 mm, 580 cm	1 szál - 5,8 m	1 profile - 5,8 m
	RLRTU-42	alumínium csőszelvény Ø 42, 580 cm	roller blind tube, aluminium, 42 mm, 580 cm	1 szál - 5,8 m	1 profile - 5,8 m
	RLRC2001-W	"S" méretű gyöngyláncos hajtómű, fehér	roller blind chain mechanism S, white	1 db	1 pc
	RLRC3001-W	"M" méretű gyöngyláncos hajtómű, fehér	roller blind chain mechanism M, white	1 db	1 pc
	RLRC3026	tengely dugó bővítő Ø 42, fehér	tube adapter M 42 mm, white	1 db	1 pc
	RLRC2002-W	tengely dugó Ø 28, fehér	easy mound end plug S 28 mm, white	1 db	1 pc
	RLRC2003-W	csap a lyukas dugóhoz, fehér	bearing pin, white	1 db	1 pc
	RLRC3004-W	tengely dugó Ø 38, fehér	easy mount end plug M 38 mm, white	1 db	1 pc
	RLRC3005-W	tengely dugó Ø 42, fehér	easy mount end plug L 42 mm, white	1 db	1 pc
	RLRC3023-W	textil határoló gyűrű, fehér	roller blind fill up ring M, white	1 db	1 pc
	RLRC2017	konzol szett S, horganyzott	roller blind bracket cassette set metal S, galvanized	1 pár	1 pair

# SQUARE S CHAIN

	CIKKSZÁM / INDEX	MEGNEVEZÉS	ARTICLE	KISZERELÉS	MOQ
	RLRC2038-W	<b>záróléc fékező műanyag szett S, fehér</b>	cassette bottom rail stopper set S, white	<b>1 pár</b>	1 pair
	RLRC2049-W	<b>tok fixáló műanyag fali szereléshez, fehér</b>	stability block for wall mounting S, white	<b>1 db</b>	1 pc
	RLRC2032-W	<b>szögletes tok oldal takaró sapka balos gyöngyös S, fehér</b>	cassette end cap square S mechanism S left, white	<b>1 db</b>	1 pc
	RLRC2033-W	<b>szögletes tok oldal takaró sapka jobbos gyöngyös S, fehér</b>	cassette end cap square S mechanism S right, white	<b>1 db</b>	1 pc
	RLRC2027-W	<b>szögletes tok oldal takaró sapka balos sima S, fehér</b>	cassette end cap square S left, white	<b>1 db</b>	1 pc
	RLRC2028-W	<b>szögletes tok oldal takaró sapka jobbos sima S, fehér</b>	cassette end cap square S right, white	<b>1 db</b>	1 pc
	RLRC2031-W	<b>szögletes tok takaró sapka jobbos S, M-es gyöngy hajtóműhöz, fehér</b>	cassette end cap square S mechanism M left, white	<b>1 db</b>	1 pc
	RLRC2034-W	<b>szögletes tok takaró sapka balos S, M-es gyöngy hajtóműhöz, fehér</b>	cassette end cap square S mechanism M right, white	<b>1 db</b>	1 pc
	RLRC2019	<b>tok hátsó S, alumínium, L-5,8 m, fehér</b>	basic cassette profile S, aluminium, L-5,8 m, white	<b>1 szál - 5,8 m</b>	1 profile - 5,8 m
	RLRC2021-W	<b>szögletes tok profil S, alumínium, L-5,8 m, fehér</b>	cassette cover S square, aluminium, L-5,8 m, white	<b>1 szál - 5,8 m</b>	1 profile - 5,8 m
	RLRC2016-W	<b>klipsz S, fehér</b>	installation bracket cassette S white	<b>1 db</b>	1 pc
	RLSL-09	<b>kefe a tokba, szürke</b>	brush for SL03, grey	<b>1 m</b>	1 m

# SQUARE S CHAIN

	CIKKSZÁM / INDEX	MEGNEVEZÉS	ARTICLE	KISZERELÉS	MOQ
* 	RLRBERW	<b>záróléc dugó, fehér</b>	roller blind head rail profile, 580 cm 25 mm, white	<b>1 pár</b>	1 pair
	RLRBRR-HS	<b>záróléc kéder</b>	hold down strip 10 mm 1 mm	<b>1 tekercs - 100 m</b>	1 roll - 100 m
* 	RLRBRRW	<b>záróléc, alumínium 580 cm, fehér</b>	roller blind bottom rail round aluminium 580 cm, white	<b>1 szál - 5,8 m</b>	1 profile - 5,8 m
	551 10 014	<b>gyöngylánc 6 x 4,5 mm, fehér</b>	ball chain 6 x 4,5 mm, white	<b>1 m</b>	1 m
	551 10 002	<b>gyöngylánc toldó, fehér</b>	ball chain connector, white	<b>1 db</b>	1 pc
	520 066	<b>végállás gyűrű</b>	ball chain stop	<b>1 db</b>	1 pc

\* Lefutósínes változatnál a jelölt alkatrészekre nincs szükség.